

MiniCard to USB Enclosure Ver1.1

Model:USBMA

History:
Ver1.0 first release
Ver1.1 change U1, C8

- [1] Impedance control required for CLK+ CLK- PETXP PETXN PERXP PERXN : 100ohm
- [2] Impedance control required for DP DN : 90ohm

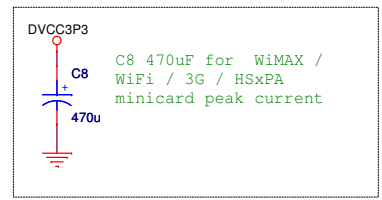
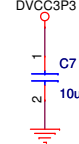
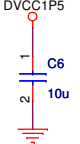
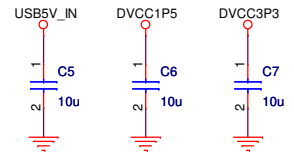
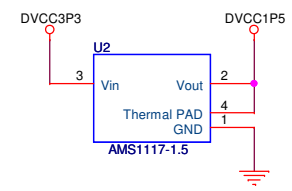
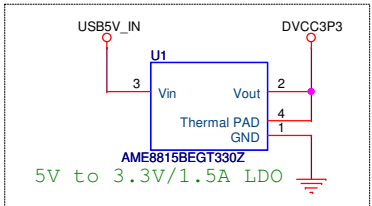
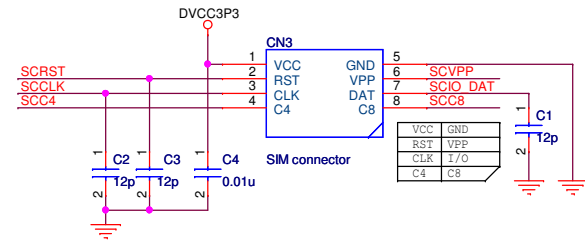
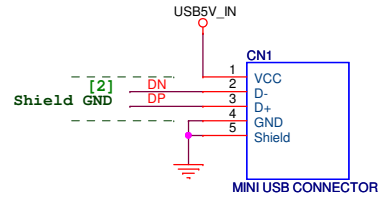
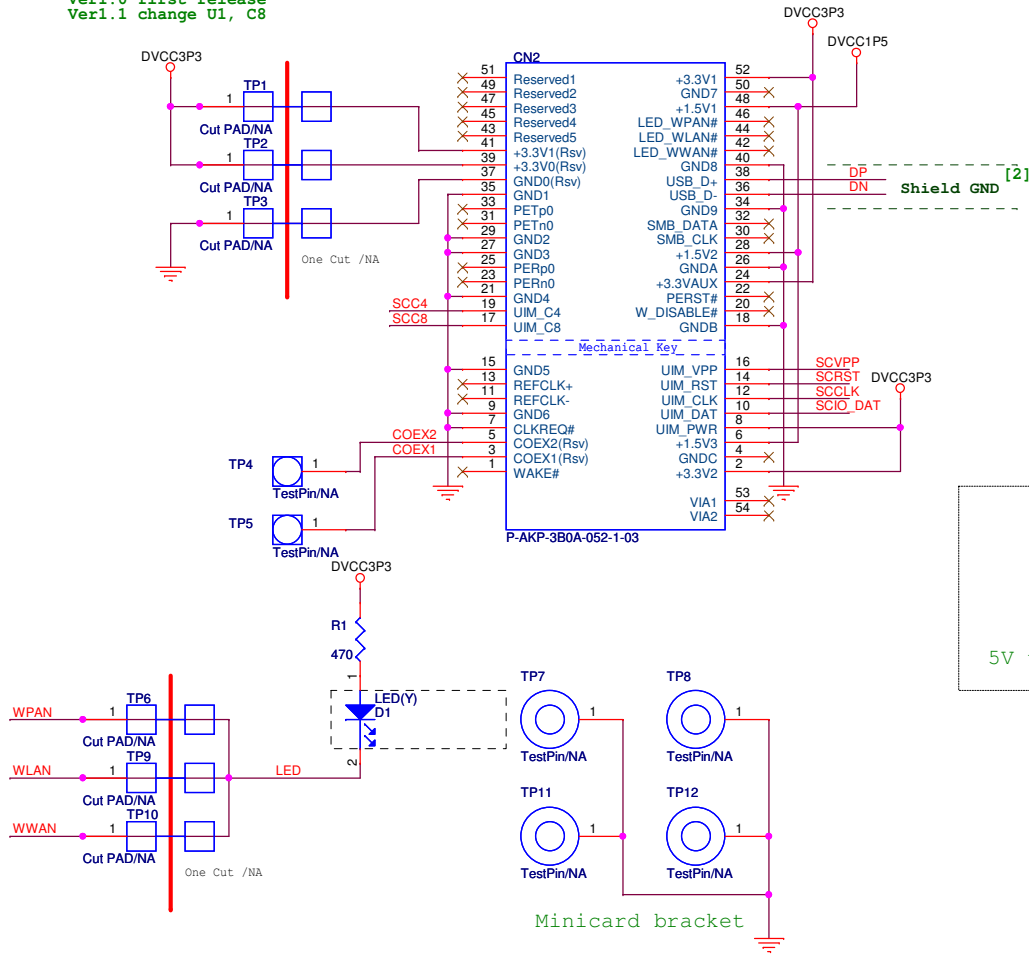

Title		
Wireless MiniCard enclosure Ver1.1		Design by:Gerry Chen
Size B	Document Number	Rev
	MiniCard Reader	1.1
Date:	Thursday, January 21, 2010	Sheet 1 of 1