

B4616A-DB32

Micro SIM to Full Size SIM Extender

Product > Extender Board > B46xxx Series

B4616A-DB32

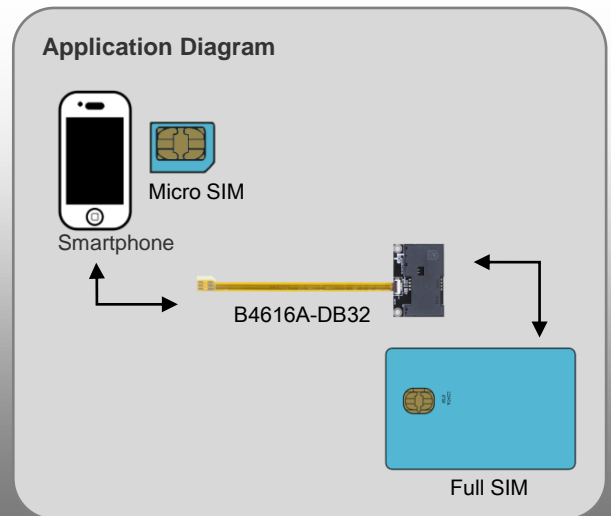

First Impression

B4616A-DB32 can use for **iPhone 5, iPhone 5s(c), new iPad and iPad mini**. It also is a debug and test tool for Micro SIM to Full Size SIM card Extender. Full SIM Card extended from host slot to Micro SIM interface with FPC cable for flexible use. The SIM extender is designed to minimize the signal degradation effects of the extender by proven design techniques. Users do not need to install any system; it is fast and easy.

B4616A-DB32 do not need to install any system; it is a powerful tool for engineers and mobile phone SIM test protection

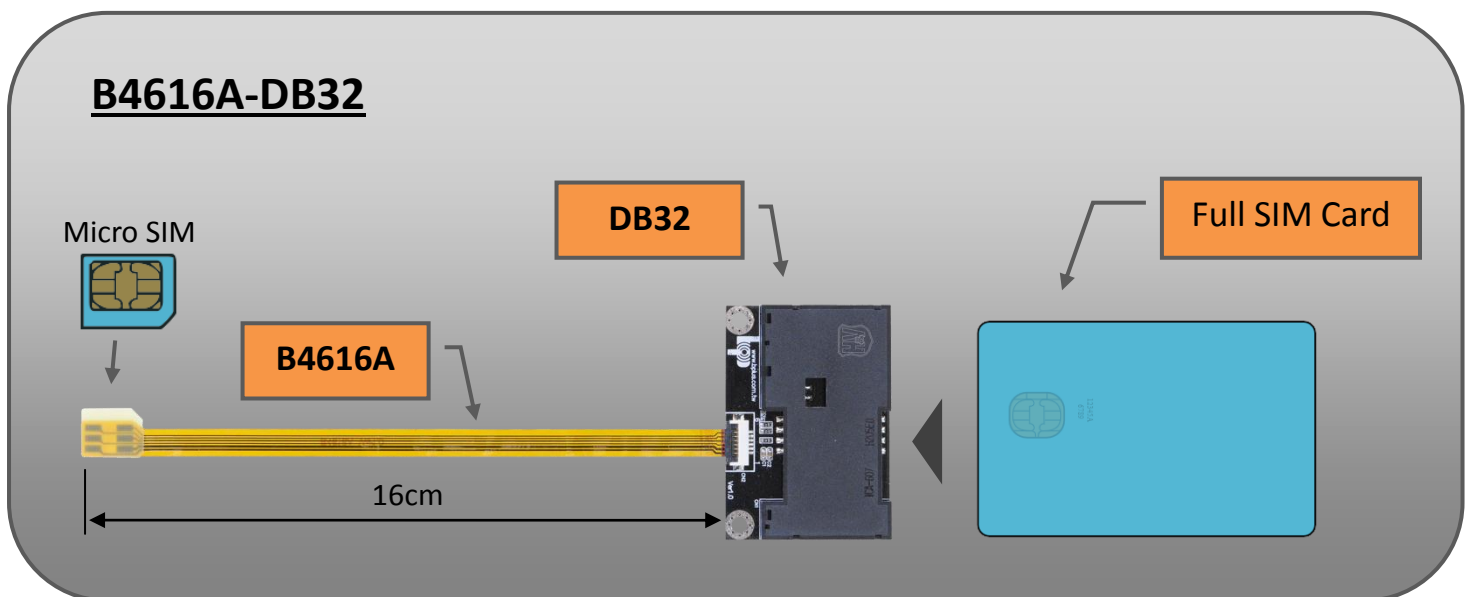

B32 / B40 / B43 / B44 / B45 / B46 series Comparison

B3214A-DB32

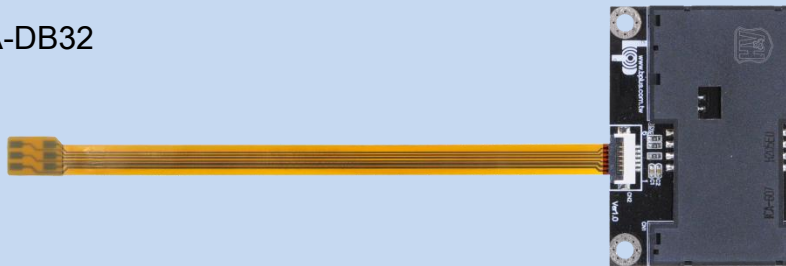

for iPhone5 / iPhone5S(c)
for NEW iPad / iPad-mini

Nano
SIM

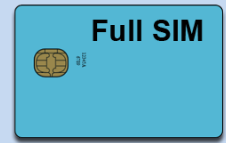

B4010A-DB43

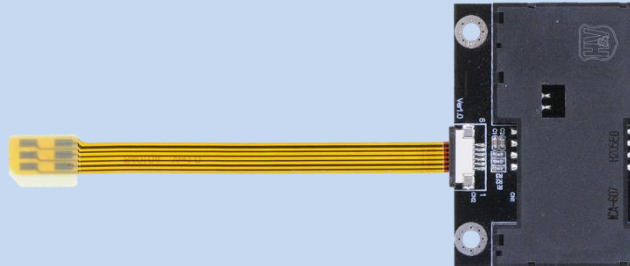

for Samsung Galaxy

Micro
SIM

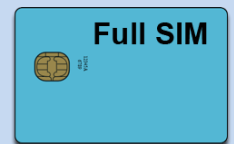

B4310A-DB43

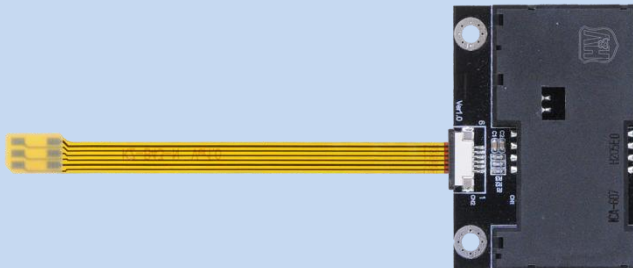

Nano
SIM

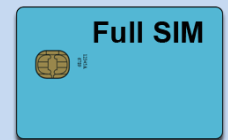

B4490A-DB44

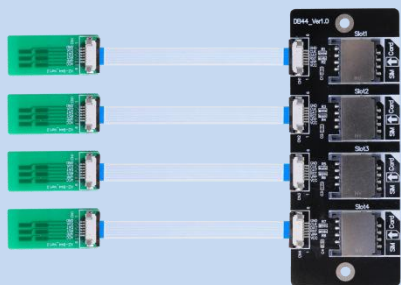

SIM

SIM



B4490A-DB32



SIM

Full SIM



B4490B-DB43

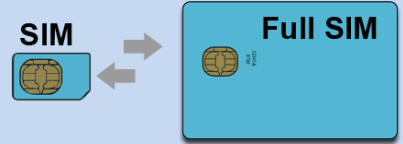

B4516A-DB43

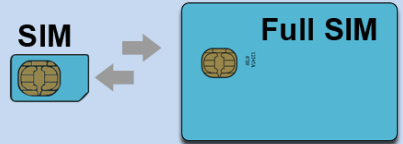

B4616A-DB32



For Apple iPhone4

