

## B4010A-DB43

Micro SIM to Full SIM Extender

Product > Extender Board > B40xxx Series

**B4010A-DB43**



**Application Diagram**

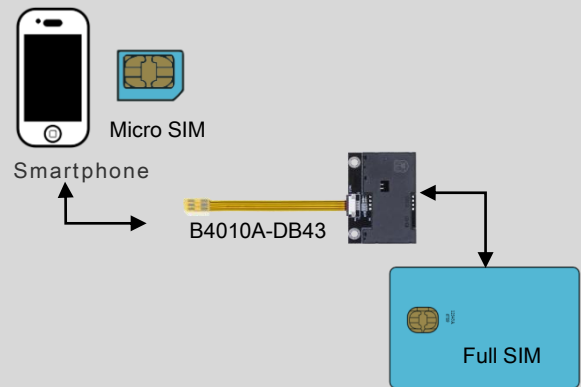

## First Impression

**B4010A-DB43** not only designs for **SAMSUNG Galaxy** but also can be strong test tool. Deign by FPC cable for flexible use also it is Micro SIM to Full SIM Card Extender on Smartphone. It is allow Micro SIM Card to be extended from the host slot to full SIM interface. The thickness of FPC is 0.1mm, B4010A-DB43 can be routed through narrow slit between body and cover case.



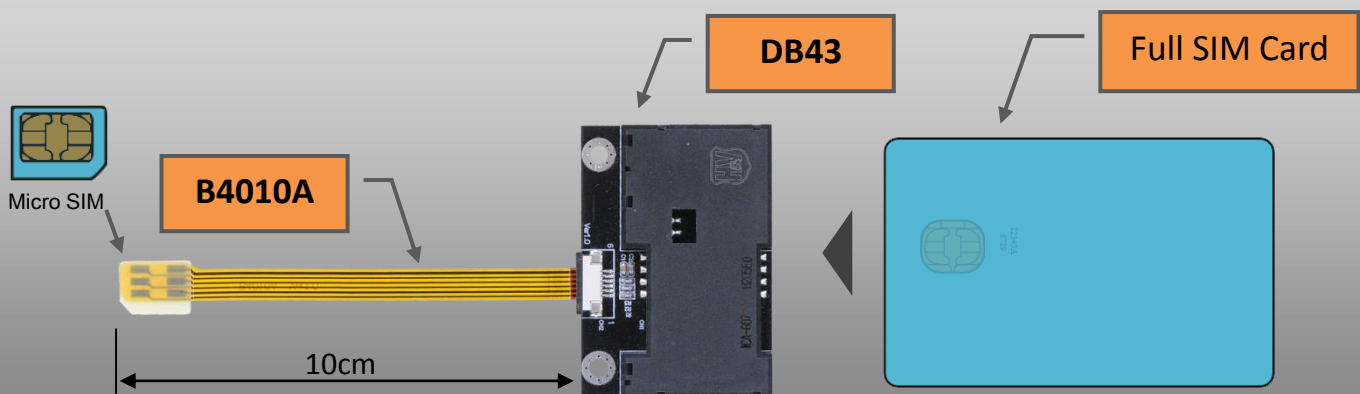

**B4010A-DB43** especially designed is to save valuable labor and time in the production environment with test pads for SIM card signals. The SIM extender is designed to minimize the signal degradation effects of the extender by proven design techniques.

It is a powerful tool for engineers and mobile phone SIM test protection.

**B4010A-DB43**

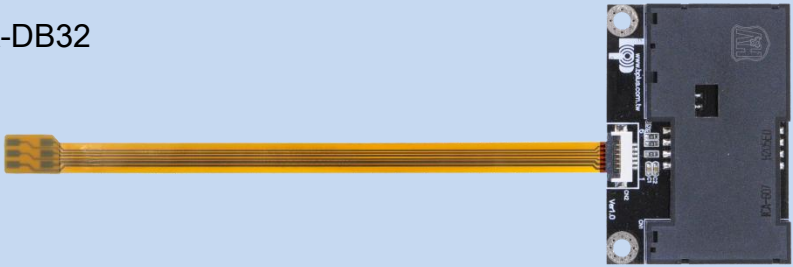

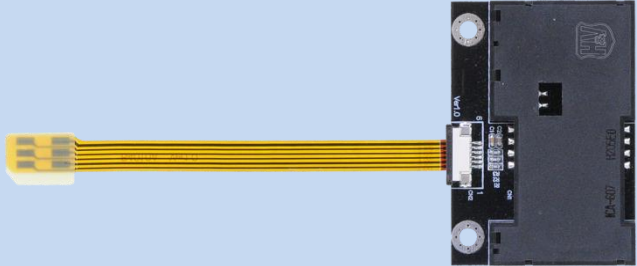
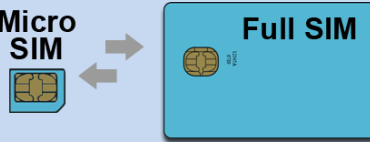
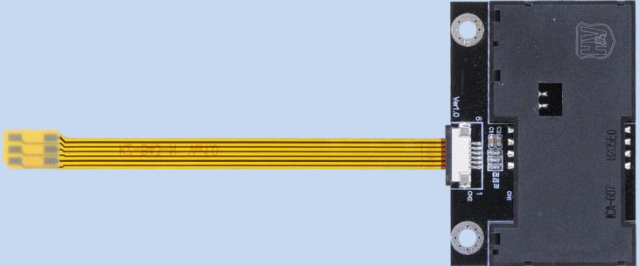
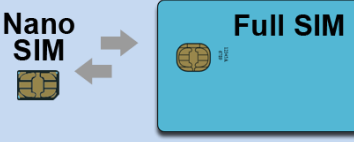
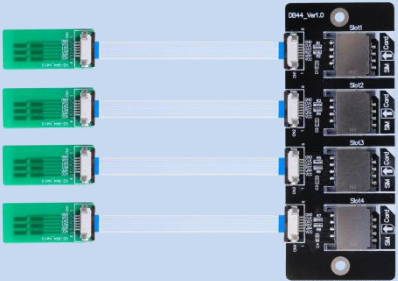
## B32 / B40 / B43 / B44 / B45 / B46 series Comparison

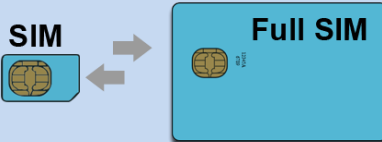
<p>B3214A-DB32</p> 	<p>for iPhone5 / iPhone5S(c) for NEW iPad / iPad-mini</p> 
<p>B4010A-DB43</p> 	<p>for Samsung Galaxy</p> 
<p>B4310A-DB43</p> 	
<p>B4490A-DB44</p> 	
<p>B4490A-DB32</p> 	

B4490B-DB43

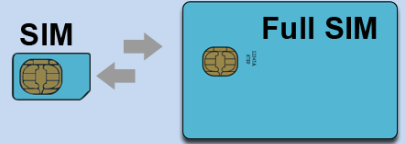

B4516A-DB43

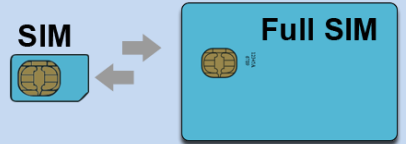

B4616A-DB32



For Apple iPhone4

